

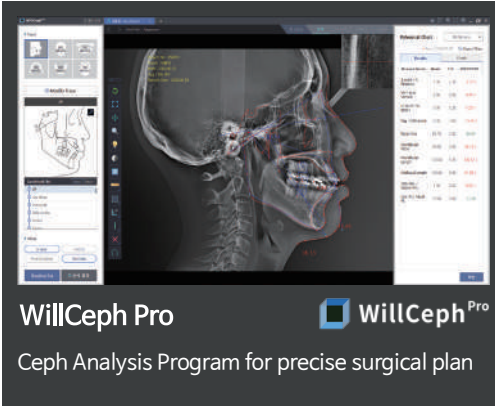

Will Master
Image Capture and Patient Management Program with Counseling Video



Will 3D
User-friendly 3D Image Analysis Program



WillCeph Pro
Ceph Analysis Program for precise surgical plan

CN-ECT)-18



Essential AI CBCT for Digital Dentistry

eco-x

// Scan Mode

Model	Series	MODE			
		CBCT	Panorama	Model Scan	Cephalo (Scan)
eco-x	eco-x	●	●	●	
	eco-x-s	●	●	●	●
	eco-x ai	●	●	●	
	eco-x-s ai	●	●	●	●

// Specifications

Function	CBCT + Panorama + Cephalo (Scan) + Model Scan
Focal Spot	0.5mm
Scan Time	CBCT : 8s or 12s, 24s
	Panorama : 14s or less
	Cephalo (option) : 8s or less
FOV Size	10x8(Child), 12x10, 16x9
Voxel Size(CT)	0.2~0.3
Tube Boltage	60kV~90kV
Tube Current	4mA~10mA
Dimension(WxDxH)	eco-x, eco-x ai : 980mm x 1255mm x 2314mm
	eco-x-s, eco-x-s ai : 1802mm x 1225mm x 2314mm

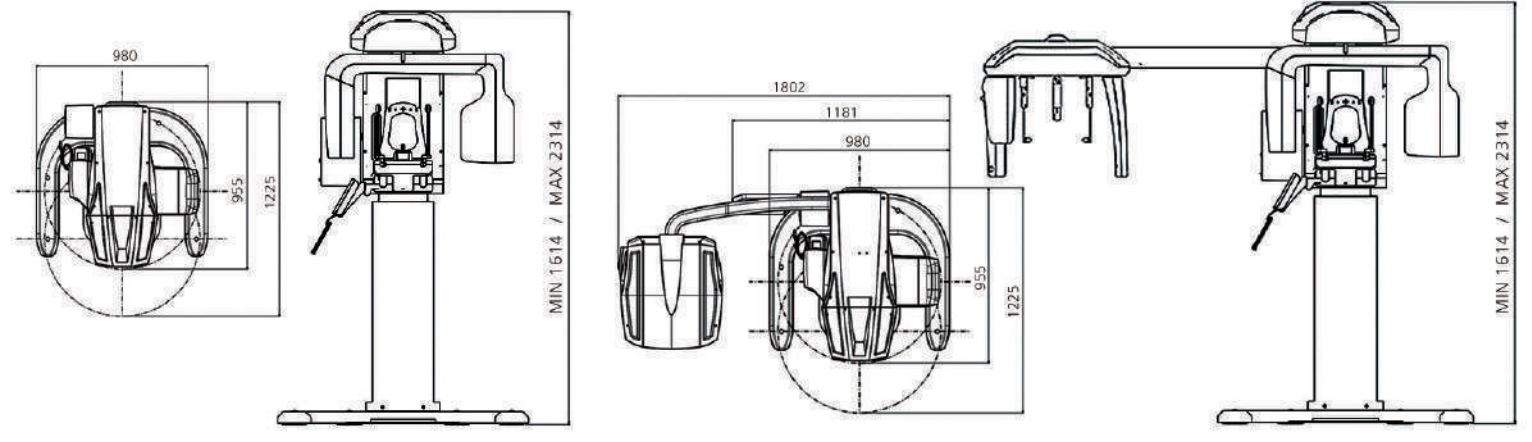

FOV 16 / FOV 12



FOV16x9



FOV12x10

Headquarter R&D Center
10F, 29, Insadong 5-gil, Jongno-gu, Seoul, Republic of Korea

Osong Factory
#105, 106, 201, 202, 203, 204, 38, Osongsaengmyeong 4-ro, Osong-eup, Heungdeok-gu, Cheongju-si, Chungcheongbuk-do, Republic of Korea

Purchase Inquiries
global@hdx.co.kr

A/S Inquiries
support@iwillmed.com



Innovation with AI Technology

- +++ No.01 Detects differences between anatomical structure and noise to provide the high definition images with lower radiation dose than Panorama
- +++ No.02 Detects the metal artifact like prosthetics to minimize distortion in anatomical structures
- +++ No.03 Automatically detects landmarks for 2D ceph tracing which is essential for orthodontic treatment

// **AEC (Auto Exposure Control) Function** Achieves superior imaging with dosage less than a panoramic scan

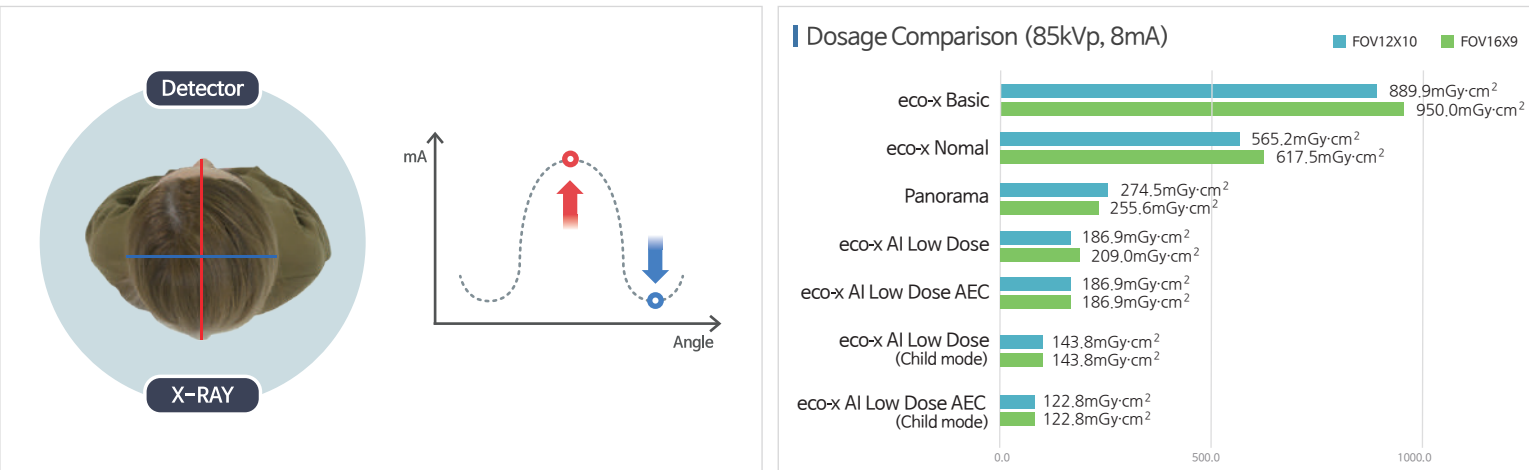

// **AI MAR** Detects difference between implant and anatomical structure, minimizing metal artifact

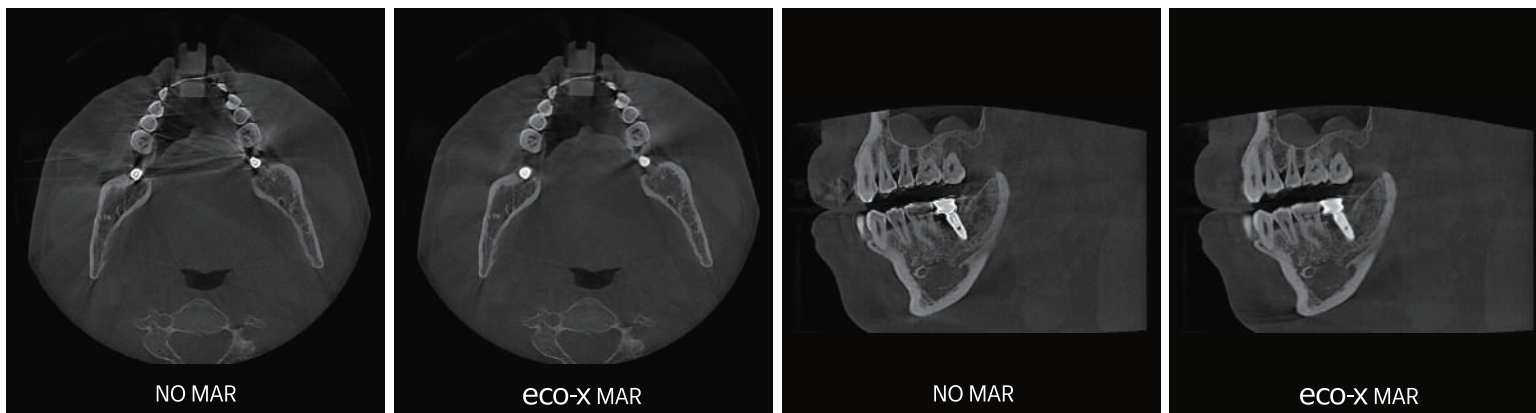

// **Auto Landmark Detection** AI automatically detects landmarks with 2D Cephalometric Scan

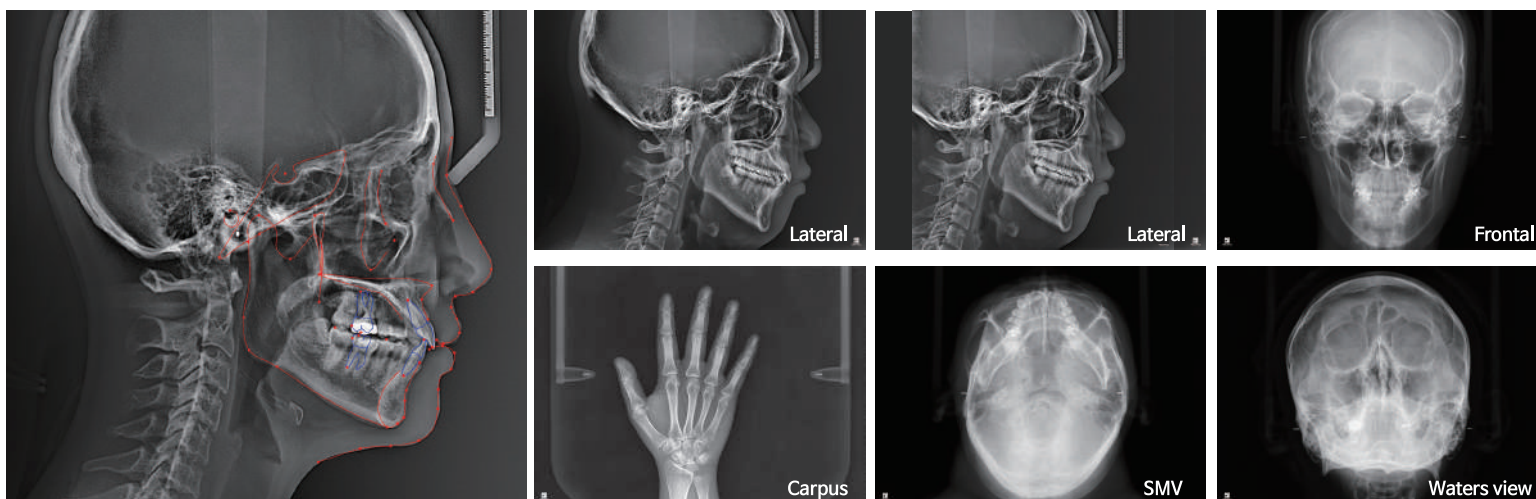

Essential Functions for Various Diagnostics

// **High Quality Image** FULL ARCH CT image of 360° for impacted tooth diagnosis and implant guide



// **PANORAMA** Dedicated 2D Panoramic Imaging for versatility

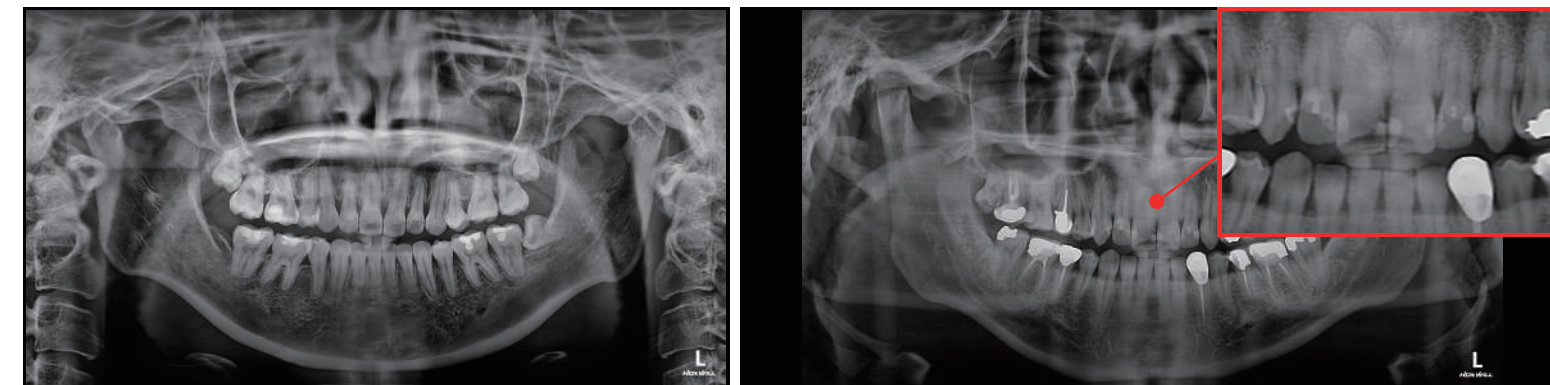

- **Auto Focus Panorama**
- **Multi Layer** allows for clear images while correcting for mispositioning Almost 3D (2.5D)

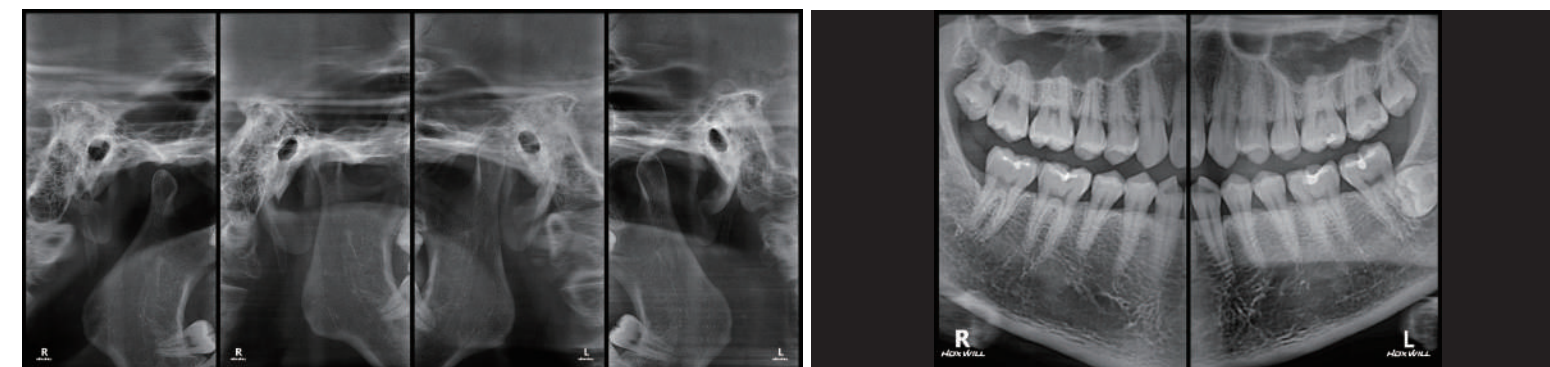

- **TMJ** Open and closed mouth mode capability
- **Bitewing** For proximal occlusal 2D image acquisition

// **Model Scan** STL file is extracted simultaneously with CBCT scan of impression or model

